



SUCTION INLET

**VIRTUS**

THE STRENGTH OF EXCELLENCE

*Beauty and strength*

[www.presavirtus.it](http://www.presavirtus.it)



# VIRTUS

Elegance and strength...  
in a suction inlet



- Shockproof
- Ergonomic opening
- Refined and elegant design
- Compatible with the main domestic inlets on the market



If you want the best for your home, Virtus by Sistem Air offers a range of suction inlets with an impeccable design, perfect for each kind of environment where they are installed.

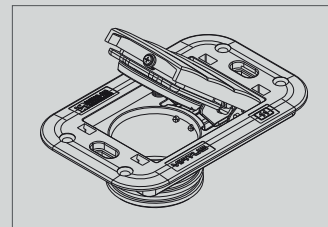



Choose the perfect match: with Virtus you will always get the best results.



On spatolato walls



On stucco lustro walls



On golden mosaic tiles

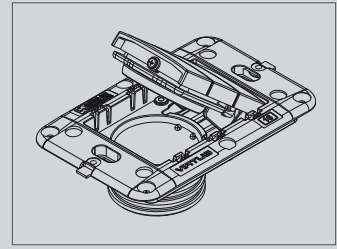

On wood walls

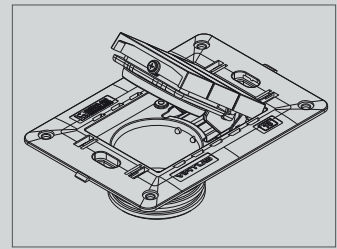

On mosaic tiles

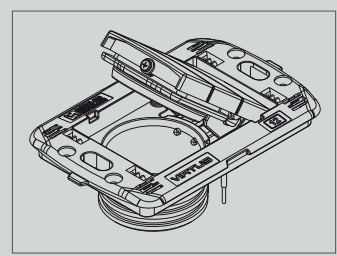

The strength of excellence

# VIRTUS

## Elegance... but not to the technique's expense

The research and development dept. of Sistem Air, thanks to its long experience in the field, developed Virtus, the suction inlet with an elegant and refined design. This inlet is versatile, simple to be installed, suitable for every environment and, above all, very strong and long lasting. It's a concentration of innovation and technology in a small and practical product.

The main characteristics of the product are the following:

### A Double seat for the o-ring

The double seat for the o-ring was conceived to reach the perfect seal with the backplate (or with the backplate extension), even though the same were not perfectly walled. This way it is possible to correct all those installations where the extension kit would be too long and just the backplate would be too short to seal with the suction inlet.

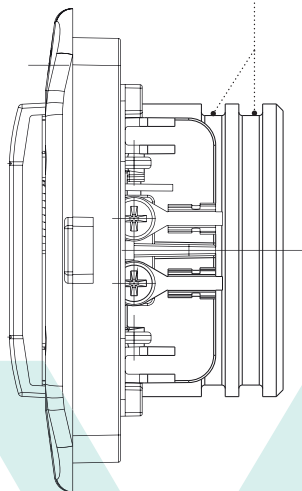

### B Structure of the frame

The form of the frame of our Virtus suction inlet is identical to the one of the corresponding domestic series, which guarantees the perfect match with the finishing frame in exactly the same way as with the electric outlets of the different brands.

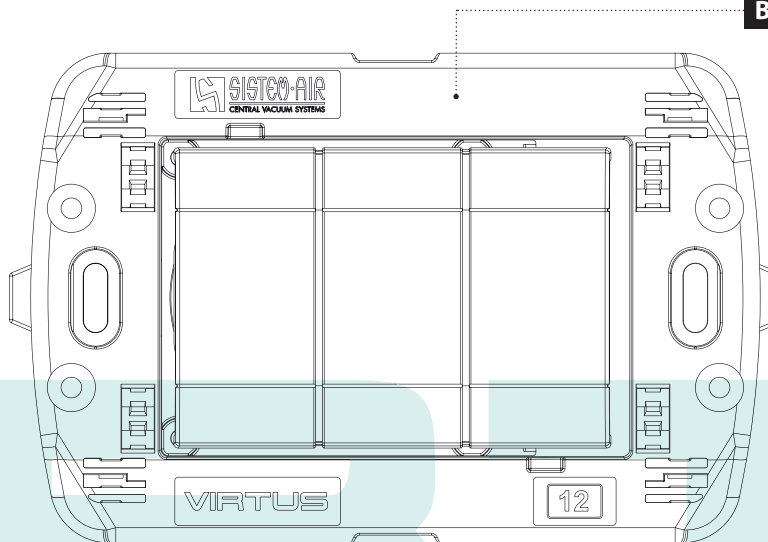

**C** Blank aesthetic cover

The basculating blank covers offer the best possible aesthetic result and allow at the same time the easy opening of the inlet, also when the system is already under depression (in the case of simultaneous users).

**D** Strength

The maximum mechanical strength was achieved thanks to the cavities realized in the interior of the box and to the several ribs on the back of the same.

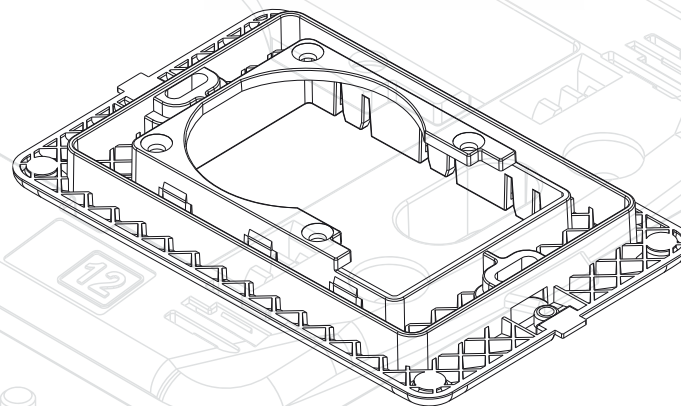

# VIRTUS



**E Bearing structure**

The four assembling screws in the inlet body and frame deeply increase the inlet's torsional rigidity, which is a necessary condition in those cases where the mounting surface is irregular.



**F Perfect seal**

The gasket was realized with a special double conic line to maintain the perfect seal of the suction inlet when closed. It was developed in SEBS gum, which prevents the memory effect, thus guaranteeing a perfect seal over the years.





**G Electric connection**

The suction inlets Virtus are equipped with 1 mmq cables which, through the wiring clips, allow an easy connection to the microline of the central unit.

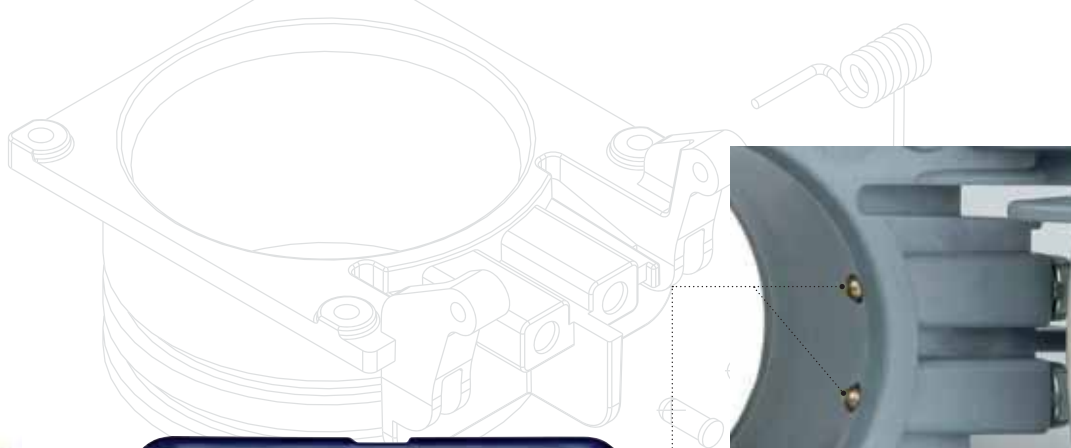

**H Electric contacts**

Virtus is a universal suction inlet, compatible with all flexible hoses on the market: both traditional and electrical on-off hoses can be connected without any problem.

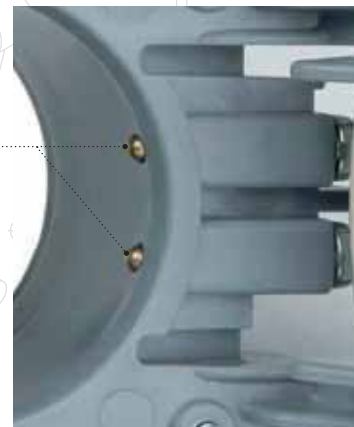

# VIRTUS

**VIRTUS** can offer:

SIMPLE installation

RELIABILITY

ELEGANT design

DURABILITY over the years

HIGH QUALITY materials

VERSATILE matching



### Virtus suction inlets for BTicino series

<b>1566.0</b>	BTicino Axolute Nera
<b>1567.0</b>	BTicino Axolute Silver
<b>1564.0</b>	BTicino Axolute Bianca
<b>1561.0</b>	BTicino Living International
<b>1562.0</b>	BTicino Living Light
<b>1565.0</b>	BTicino Living Light Tech
<b>1569.0</b>	BTicino Matix Bianca
<b>1570.0</b>	BTicino Air Nera
<b>1571.0</b>	BTicino Air Bianca
<b>1572.0</b>	BTicino Air Tech

### Virtus suction inlets for Vimar series

<b>1558.0</b>	Vimar Eikon Nera
<b>1558.1</b>	Vimar Eikon Bianca
<b>1553.5</b>	Vimar Eikon Next
<b>1553.6</b>	Vimar Eikon Evo Next
<b>1553.7</b>	Vimar Eikon Evo Antracite
<b>1553.8</b>	Vimar Eikon Evo Bianca
<b>1553.4</b>	Vimar Plana Bianca
<b>1553.3</b>	Vimar Plana Silver
<b>1553.0</b>	Vimar Idea Nera
<b>1553.2</b>	Vimar Idea Bianca

### Virtus suction inlets for Simon Urmet Nea

<b>1543.0</b>	Simon Urmet Nea Antracite
<b>1543.1</b>	Simon Urmet Nea Bianca
<b>1543.2</b>	Simon Urmet Nea Acciaio scuro
<b>1543.3</b>	Simon Urmet Nea Bianco Ghiaccio
<b>1543.4</b>	Simon Urmet Nea Alluminio

# VIRTUS

THE STRENGTH OF EXCELLENCE

[www.presavirtus.it](http://www.presavirtus.it)